

SOKKIA

**TM1A
TM6
TM20H·TM20HS
TM20E·TM20ES
T60E·TS20A**

THEODOLITES

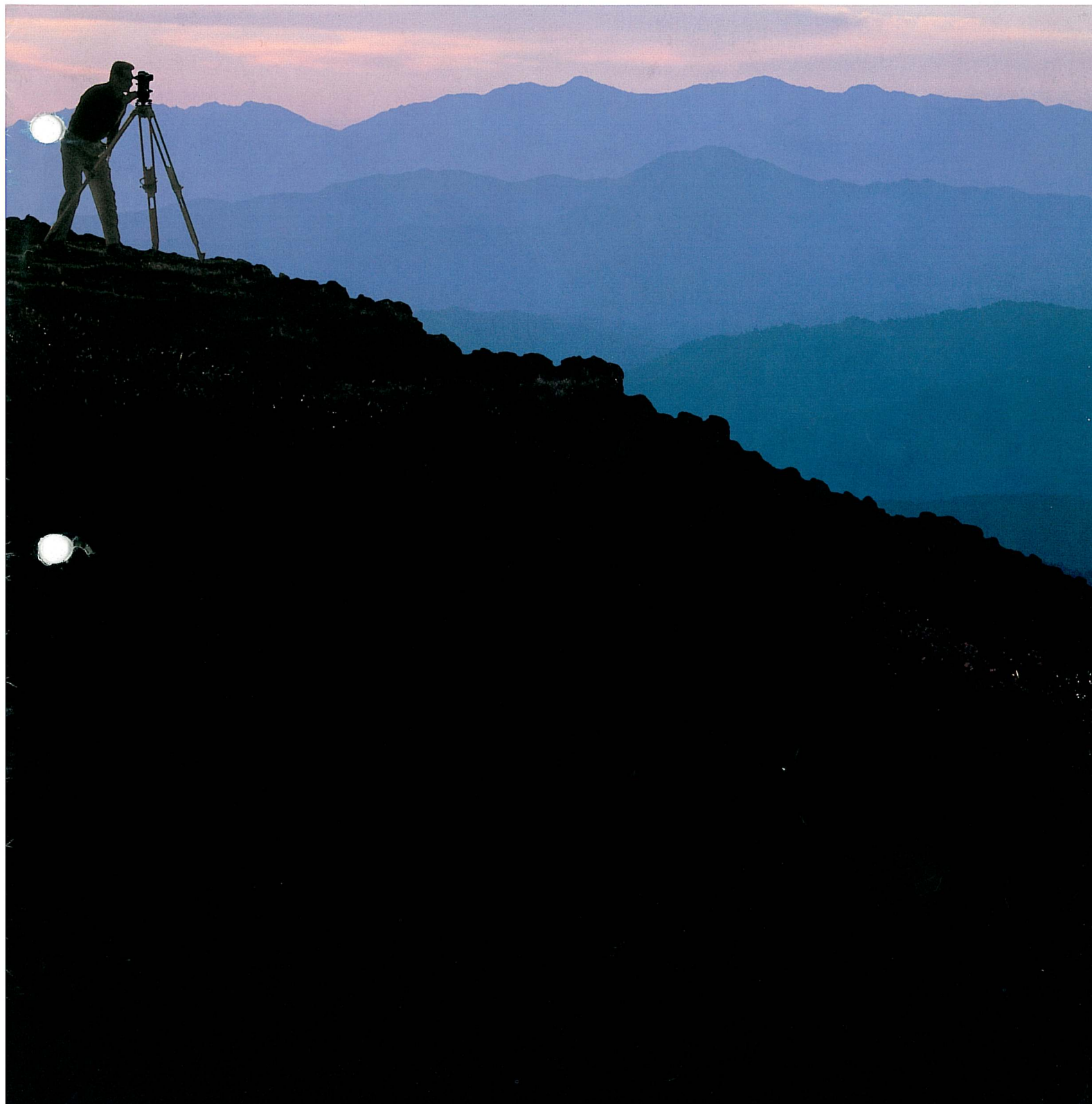

TM1A

ONE SECOND THEODOLITE



The perfect instrument for your precision survey work

The Sokkia TM1A one second theodolite has been superbly designed and built to produce a highly precise, easy to use instrument. Tested and acclaimed by government survey bodies, the TM1A is ideal for a wide variety of surveying tasks, including triangulation and precise traversing.



TM1A

The TM1A micrometer theodolite is equipped with a high precision axis and circles with direct reading to 1" (0.1mgon), and estimation to 0.1" (0.01mgon).

Diametrical projection system

Both horizontal and vertical circle graduations are displayed by means of a special co-incident image projection method developed by Sokkia. The system eliminates circle eccentricity error.

Clear and sharp micrometer windows

Sharp graduations and clear windows provide precise reading. The background color of the micrometer confirms the selection of vertical or horizontal angle reading — aqua for the zenith angle reading, soft green for the horizontal angle.

Magnetic vertical circle compensator

The magnetically damped vertical circle compensator always provides an accurate reading of the precise zenith angle.

Auto-collimation eyepiece

With the ACE2 Auto-collimation eyepiece, the TM1A serves as an auto-collimator.

Combination with EDM

Attachments are available to mount any of the Sokkia's electronic distance meters on the TM1A.

TM1A

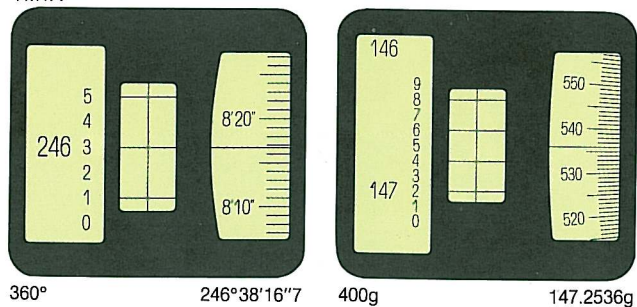

360°

246°38'16"7

400g

147.2536g

TM1A Specifications

Telescope	
Length	170mm (6.7 in.)
Objective aperture	45mm (1.8 in.)
Magnification	30X
Image	Erect
Resolving power	2.5"
Field of view [at 1000m]	1°30' [26m]
Minimum focus	1.3m (4.3 ft.)
Stadia multiplication constant	100
Stadia additive constant	0cm
Reticle illumination	by LA1
Angle measurement	Micrometer reading
Horizontal circle	Diametrical projection, Clockwise reading
Diameter	94mm (3.7 in.)
Direct reading	1" (0.1mgon)
Estimation	0.1" (0.01mgon)
Vertical circle	Diametrical projection, Zenith angle reading
Diameter	80mm (3.1 in.)
Direct reading	1" (0.1mgon)
Estimation	0.1" (0.01mgon)
Vertical compensator	
Damping system	Magnetic
Range	± 2'
Setting accuracy	0.3"
Circle illumination	by LA1
General	
Sensitivity of levels	
Plate level	20" /2mm
Circular level	10' /2mm in tribrach
Optical plummet	In alidade
Image	Erect
Magnification	2X
Minimum focus	0.5m (1.6 ft.)
Standing axis	Single
Tilting axis height	
from tribrach bottom	248mm (9.8 in.)
from tribrach dish	205mm (8.1 in.)
Size (W × D × H)	189 × 170 × 300mm (7.4 × 6.7 × 11.8 in.)
Weight	6.0kg (13.2 lbs.)
Base screw	φ 5/8 inch

Designs and specifications are subject to change without notice.



Horizontal circle orientation knob

The TM1A Theodolite comes complete with:

Main unit with WA Tribrach, LA1 Illumination unit, Sunshade, Lens cap, Plumb bob, Vinyl cover, Tool kit, Operator's manual and Carrying case.

When placing your order, please specify the required angle unit: 360° sexagesimal or 400gon.

TM6 TM20H • TM20HS TM20E • TM20ES

DIGITAL THEODOLITES

TM6 Six second (2mgon) Digital Theodolite, estimation to 3" (1mgon), equipped with a vertical circle compensator.

TM20H • TM20HS Twenty Second (5mgon) Digital Theodolites, estimation to 10" (2.5mgon), equipped with a vertical circle compensator.

TM20E • TM20ES Twenty Second (5mgon) Digital Theodolites, estimation to 10" (2.5mgon).

These ruggedly constructed theodolites incorporate easy-to-read digital micrometer reading systems. These models are quite useful for various types of surveying, such as traversing, cadastral surveying, civil engineering, construction and mining.

The TM6 employs a diametrical projection system to display the horizontal circle graduation to eliminate circle eccentricity error. It also incorporates a magnetically damped vertical circle compensator for faster and more accurate compensation of the zenith angle.

The TM20H and TM20HS are also equipped with the magnetic vertical circle compensator.

The TM20E and TM20ES are fitted with a 40" /2mm telescopic level for precise perpendicularity of

the standing axis.

All these models employ a repetition system.

Vertical circle compensator

For fast and accurate vertical angle measurement, the TM6, TM20E and TM20ES have a magnetically damped vertical circle compensator with a wide compensation range.

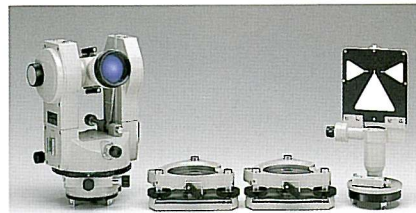
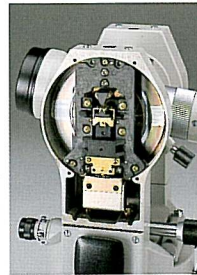

Detachable tribrach

The TM6, TM20H and TM20E are equipped with a detachable tribrach for convenient traverse surveying. The instruments are easily removed from the tribrach, allowing traversing targets or reflecting prism sets to be mounted. The tripods to be used with these instruments must have a head screw diameter of 5/8 inch.



Shifting tribrach

The TM20HS and TM20ES are equipped with a permanently mounted shifting base for rapid centering. Once the theodolite is levelled, the surveying point is easily centered with the optical plummet. These models require a tripod with a head screw diameter of 35mm.



TM20E • TM20ES

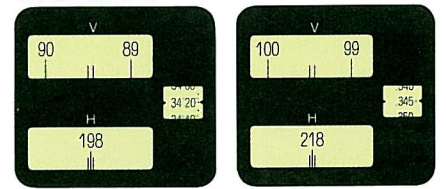

360° H:198°34'20"

400g H:218.345g

TM20H



TM20E





TM6 • TM20H • TM20HS • TM20E • TM20ES Specifications

	TM6	TM20H TM20HS	TM20E TM20ES
Telescope			
Length	170mm (6.7 in.)	160mm (6.3 in.)	
Objective aperture	45mm (1.8 in.)		
Magnification	30X		
Image	Erect		
Resolving power	3"		
Field of view [at 1000m]	1° 30' [26m]		
Minimum focus	1.3m (4.3 ft.)		
Stadia multiplication constant	100		
Stadia additive constant	0cm		
Reticle illumination	by LA1		
Angle measurement			
Micrometer reading			
Horizontal circle	Diametrical projection, Clockwise reading	Clockwise reading	
Diameter	80mm (3.1 in.)	76mm (3.0 in.)	
Direct reading	6" (2mgon) digital	20" (5mgon) digital	
Estimation	3" (1mgon)	10" by dot (2.5mgon)	
Vertical circle	Zenith angle reading		
Diameter	70mm (2.8 in.)	76mm (3.0 in.)	
Direct reading	6" (2mgon) digital	20" (5mgon) digital	
Estimation	3" (1mgon)	10" by dot (2.5mgon)	
Vertical compensator			
Damping system	Magnetic		n/a
Range	±5"		n/a
Setting accuracy	0.5"		n/a
Circle illumination	by LA1		
General			
Sensitivity of levels			
Telescope level	n/a		40" / 2mm
Plate level	30" / 2mm	30" / 2mm (HS: 40" / 2mm)	40" / 2mm
Circular level	10" / 2mm in tribrach		
Optical plummet			
Image	Erect		
Magnification	2X		
Minimum focus	0.5m (1.6 ft.)	0.1m (0.33 ft.)	
Standing axis	Double		
Tilting axis height			
from tribrach bottom	233mm (9.2 in.)		
from tribrach dish	190mm (7.5 in.)		
Size			
Width	165mm (6.5 in.)	172mm (6.8 in.)	174mm (6.9 in.)
Depth	174mm (6.9 in.)	160mm (6.3 in.)	160mm (6.3 in.)
Height	283mm (11.1 in.)	282mm (11.1 in.)	282mm (11.1 in.)
Weight	5.6kg (12.3 lbs.)	4.6kg (10.1 lbs.) [HS: 4.1kg (9.0 lbs.)]	4.6kg (10.1 lbs.) [ES: 4.0kg (8.8 lbs.)]
Base screw	φ 5/8 inch	φ 5/8 inch [HS: φ 35mm]	φ 5/8 inch [ES: φ 35mm]

Specifications not listed under specific instruments are identical to those appearing on the left. Designs and specifications are subject to change without notice.

TM6

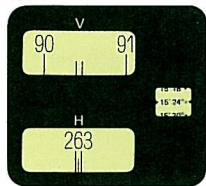

360° H:263°15'24"

TM6

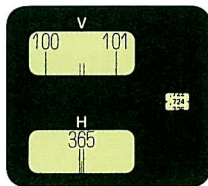

400g H:365.724g

Displays

The digital micrometer display has three soft green windows for rapid, easy read-out.

Diametrical projection system

The TM6 incorporates an advanced system of prisms that doubles the image of the horizontal circle to eliminate circle eccentricity error.

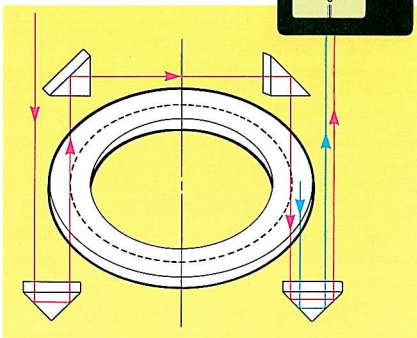
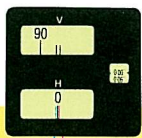

Sighting telescope

The 30X magnification sighting telescope, using a 45mm diameter objective lens and a clear reticle, ensures highly accurate and reliable target sighting. Horizontal distance is easily measured with the superimposed stadia lines.

Optical plummet

The optical plummet located in the alidade makes it easy to center the instrument exactly over the surveying point.

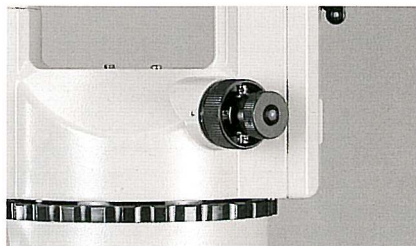

Combination with EDM

Sokkia's RED series EDM can be mounted on any of these theodolites for combined angle and distance measurement.

The TM6, TM20H and TM20E Theodolites come complete with:

Main unit with WA Tribrach, LA1 Illumination unit, Tubular compass, Sunshade, Lens cap, Plumb bob, Vinyl cover, Tool kit, Operator's manual and Carrying case.

The TM20HS and TM20ES Theodolites come complete with:

Main unit fitted with shifting base, LA1 Illumination unit, Tubular compass, Sunshade, Lens cap, Plumb bob, Vinyl cover, Tool kit, Operator's manual and Carrying case.

When placing your order, please specify the required angle unit: 360° sexagesimal or 400gon.

T60E • TS20A

SCALE-READING THEODOLITES

T60E



TS20A



T60E One Minute (10mgon) Scale-reading Theodolite, horizontal circle estimation to 20" (5mgon), equipped with a magnetic vertical circle compensator and detachable tribrach.

TS20A One Minute (10mgon) Scale-reading Theodolite, horizontal circle estimation to 20" (5mgon), equipped with a double numbering horizontal circle (360° model) and shifting tribrach.

The T60E and TS20A are reliable and convenient instruments for most surveying tasks, including engineering and mining applications. They feature clear, easy-to-read scales for rapid angle reading.

The T60E is equipped with a magnetically damped vertical circle compensator for fast and accurate zenith angle compensation. The tribrach is detachable, so the instrument is easily replaced with traversing target or reflecting prism sets.

The TS20A (360°) has a double-reading horizontal circle allowing direct clockwise and counter-clockwise reading. It is fitted with a permanently mounted shifting base for rapid centering.

The optical plummet in each instrument is located in the alidade to rotate with the instrument and to ensure proper adjustment at all times.

T60E • TS20A Specifications

	T60E	TS20A
Telescope		
Length	160mm (6.3 in.)	
Objective aperture	45mm (1.8 in.)	
Magnification	30X	
Image	Erect	
Resolving power	3"	
Field of view [at 1000m]	1° 30' [26m]	
Minimum focus	1.3m (4.3 ft.)	
Stadia multiplication constant	100	
Stadia additive constant	0cm	
Reticle illumination	by LA1	
Angle measurement		
Scale reading		
Horizontal circle	Single numbering	360°: Double numbering 400gon: Single numbering
Diameter	82mm (3.2 in.)	
Direct reading	1' (10mgon)	
Estimation	20" (5mgon)	
Vertical circle		
Zenith angle reading		
Diameter	76mm (3.0 in.)	
Direct reading	1' (10mgon)	
Vertical compensator		
Damping system	Magnetic	n/a
Range	±5'	n/a
Setting accuracy	0.5"	n/a
Circle illumination	by LA1	
General		
Sensitivity of levels		
Telescope level	n/a	40" /2mm
Plate level	30" /2mm	40" /2mm
Circular level	10' /2mm in tribrach	
Optical plummet		
In alidade		
Image	Erect	
Magnification	2X	
Minimum focus	0.1m (0.33 ft.)	
Standing axis		
Double		
Tilting axis height		
from tribrach bottom	233mm (9.2 in.)	n/a
from tribrach dish	190mm (7.5 in.)	n/a
Size	Width 160mm (6.3 in.) Depth 160mm (6.3 in.) Height 282mm (11.1 in.)	160mm (6.3 in.) 160mm (6.3 in.) 277mm (10.9 in.)
Weight	4.4kg (9.7 lbs.)	3.9kg (8.6 lbs.)
Base screw	φ 5/8 inch	φ 35mm (φ 5/8 inch as an option)

Specifications not listed under specific instruments are identical to those appearing to the left. Designs and specifications are subject to change without notice.

ACCESSORIES

T60E

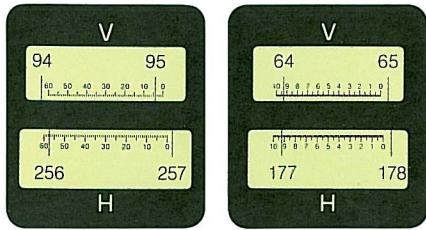

360° V: 95° 4' H: 256° 57' 20"
400g V: 64.93g H: 177.925g

TS20A

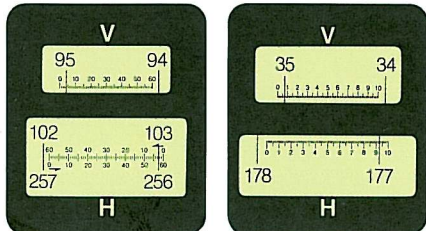

360° V: 95° 4' H: -103° 2' 40"
-256° 57' 20"
400g V: 35.07g H: 177.925g

Combination with EDM

Sokkia's RED series EDM can be mounted on any of these theodolites for combined angle and distance measurement.

The T60E Theodolite comes complete with:

Main unit with WA Tribrach, LA1 Illumination unit, Tubular compass, Sunshade, Lens cap, Plumb bob, Vinyl cover, Tool kit, Operator's manual and Carrying case.

The TS20A Theodolite comes complete with:

Main unit fitted with shifting base, LA1 Illumination unit, Tubular compass, Sunshade, Lens cap, Plumb bob, Vinyl cover, Tool kit, Operator's manual and Carrying case.

A TS20A fitted with a 5/8-inch diameter base screw, for use with a tripod with a 5/8-inch diameter head screw, is available on request.

When placing your order, please specify the required angle unit: 360° sexagesimal or 400gon.

EF2 Eyepiece solar filter

Protects the eye from direct sunlight during solar observation.

EP2 Eyepiece prism

Attached directly to eyepieces for comfortable sightings at steep angles.

DE14, DE12, DE10 Diagonal eyepiece

Allows sightings at steep angles up to the zenith angle.

MA04A Diagonal eyepiece solar filter

For use in solar observations, it can be attached to telescope diagonal eyepieces.

CP4 (360°), CP4G (400gon) Circular compass

Permits reading of the compass from the telescope sighting position.

ACE2 Auto-collimation eyepiece

Allows the TM1A telescope to be used as an auto-collimator. (A properly designed reflector for specific use needs to be prepared locally.)

LA1 Illumination unit

Illuminates reticle and circles for work under low-lighting conditions.

Targets

TG1 Traversing target set (set of two)

TG2 Traversing target set (set of two)

TGLP Large Target Plate (set of two)

The TG1 has an optical plummet in the alidade, while the TG2 has it in the tribrach. The TGLP can be attached to either of the target sets.

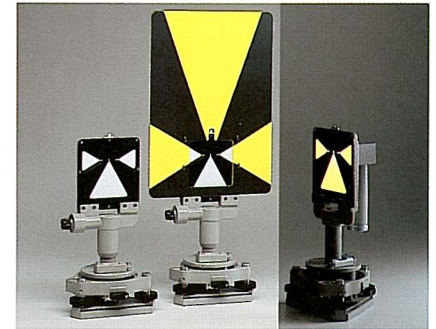

Tripods

PFW1 Hardwood telescopic tripod (Head screw diameter 5/8 inch)

PFA1 Aluminum telescopic tripod (Head screw diameter 5/8 inch)

PFA2 Aluminum telescopic tripod (Head screw diameter 35mm); for TM20HS, TM20ES and TS20A



Applications

	TM1A	TM6	TM20H•TM20HS TM20E•TM20ES T60E•TS20A
Eyepiece solar filter	EF2	EF2	EF2
Eyepiece prism	EP2	EP2	EP2
Diagonal eyepiece	DE14	DE12	DE10
Diagonal eyepiece solar filter	MA04A	MA04A	MA04A
Circular compass	Not recommended	CP4 (360°) CP4G (400gon)	CP4 (360°) CP4G (400gon)
Auto-collimation eyepiece	ACE2	n/a	n/a
Illumination unit	LA1*	LA1*	LA1*
Tubular compass	Not recommended	1*	1*

* Included in each complete set.

TG1•TG2

Consist of:

	TG1	TG2
Rotatable sighting target	TG1SP × 2 pcs. (with optical plummet)	TG2SP × 2 pcs.
Tribrach	WA × 2 pcs.	WOA × 2 pcs. (with optical plummet)
Illumination unit	LA2 × 2 pcs.	LA2 × 2 pcs.
Spare bulb	1 pc.	1 pc.
Carrying case	1 pc.	1 pc.

Specifications:

	TG1	TG2	TGLP
Size of target plate	110 × 100mm		300 × 200mm
Weight (w/o carrying case)	3.6kg (2 pcs.)	4.2kg (2 pcs.)	0.57 kg (2 pcs.)
Batteries	Standard "C" × 4 pcs.		n/a
Bulb	2.5V, 0.3A		n/a

Specifications not listed under specific instruments are identical to those appearing to the left. Designs and specifications are subject to change without notice.

SOKKIA Options and Combination System for Multi-Purpose Surveying

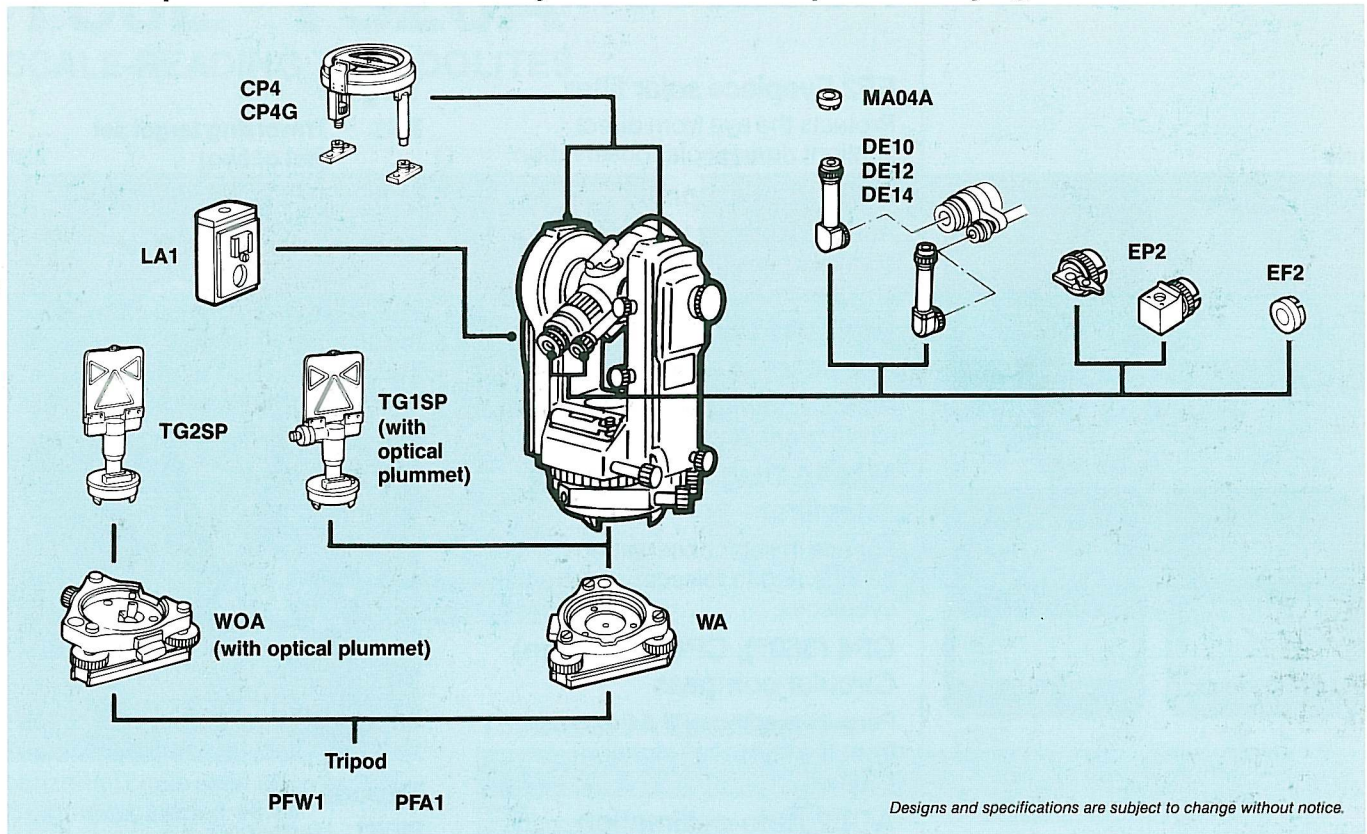

EDM Mounting is available in the following combinations:

	RED2A*RED2L*RED2LV		REDMINI2	
	Telescope mounting	Standard mounting	Telescope mounting	Standard mounting
TM1A	yes	yes	yes	yes
TM6	yes	yes	yes	yes
TM20H*TM20HS	yes	yes	yes	yes
TM20E*TM20ES	n/a	yes	n/a	yes
T60E	yes	yes	yes	yes
TS20A	n/a	yes	n/a	yes

For attachments and other details, please see the individual EDM brochures or general catalog.

SOKKIA CO.,LTD.

1-1, TOMIGAYA 1-CHOME, SHIBUYA-KU, TOKYO, 151 JAPAN
 PHONE 03-3465-5211 FAX 03-3465-5203 TELEX SURSOK J28518
 INTERNATIONAL DEPT. PHONE 03-3302-7033 FAX 03-3302-7133

SOKKIA CORPORATION 9111 Barton, P.O. Box 2934, Overland Park, Kansas 66201, U.S.A., Phone 913-492-4900
 SOKKIA INC. 820 Denison Street, Unit 1, Markham, Ontario, Canada L3R 3K5, Phone 416-475-1450
 SOKKIA PTY. LTD. 107 Leicester Street, Carlton, Victoria 3053, Australia, Phone 03-347-5844
 SOKKIA NEW ZEALAND 20 Constellation Drive, Marangi Bay, Auckland 10, C.P.O. Box 4464, Auckland, New Zealand, Phone 09-479-3064
 SOKKIA B.V. Businesspark De Vaart, Damsluisweg 1, 1332 EA Almere, P.O. Box 1292, 1300 BG Almere, The Netherlands, Phone 036-53-22-880
 SOKKIA LTD. Electra Way, Crewe Business Park, Crewe, Cheshire, CW1 1ZT, United Kingdom, Phone 0270-250525
 SOKKIA GmbH An der Wachsfabrik 25, 5000 Köln 50 (Rodenkirchen), Germany, Phone 02236-64058
 SOKKIA S.A. 12, Avenue Gabriel Peri, 78360 Montesson, France, Phone 1-30-53-09-73
 SOKKIA S.R.L. Via Bologna 50, 10152 Torino, Italy, Phone 011-248-0080
 SOKKIA AB Transportgatan 5, S-422 46 Hisings Backa, Sweden, Phone 031-581550
 SOKKIA N.V. Sphere Businesspark, Doornveld 1-1A, B-1731 Zellik (Brussels), Belgium, Phone 02-466-82-30
 SOKKIA KOREA CO.,LTD. Rm. 401, Kwan Seo Bldg, 561-20 Sinsa-Dong, Kangnam-ku, Seoul, Republic of Korea, Phone 02-514-0491
 SOKKIA SINGAPORE PTE. LTD. 401 Commonwealth Drive, #06-01 Haw Par Technocentre, Singapore 0314, Phone 479-3966 Fax 479-4966
 SOKKIA (M) SDN.BHD. No 88 Jln SS 24/s Taman Megah, 47301 Petaling Jaya, Selangor Darul Ehsan, Malaysia, Phone 03-7764240
 SOKKIA HONG KONG CO.LTD. Rm 1406 Shatin Galleria, Shan Mei Street, Fo Tan, Shatin, New Territories, Hong Kong, Phone 852-6910280
 SOKKIA GULF P.O.Box 4801, Dubai, U.A.E., Phone 9714-690965
 SOKKIA CO.,LTD. SHANGHAI REP. OFFICE No.170 Nanjing W. Road, Shanghai, People's Republic of China, Phone 3183220